

STARGAZER SHOE BASE FLAGPOLE ASSEMBLY

35 FOOT - 35" DIAMETER

STARGAZER MODEL:
SG-PA-35
INFO@EMFLAG.COM (512) 847-0010

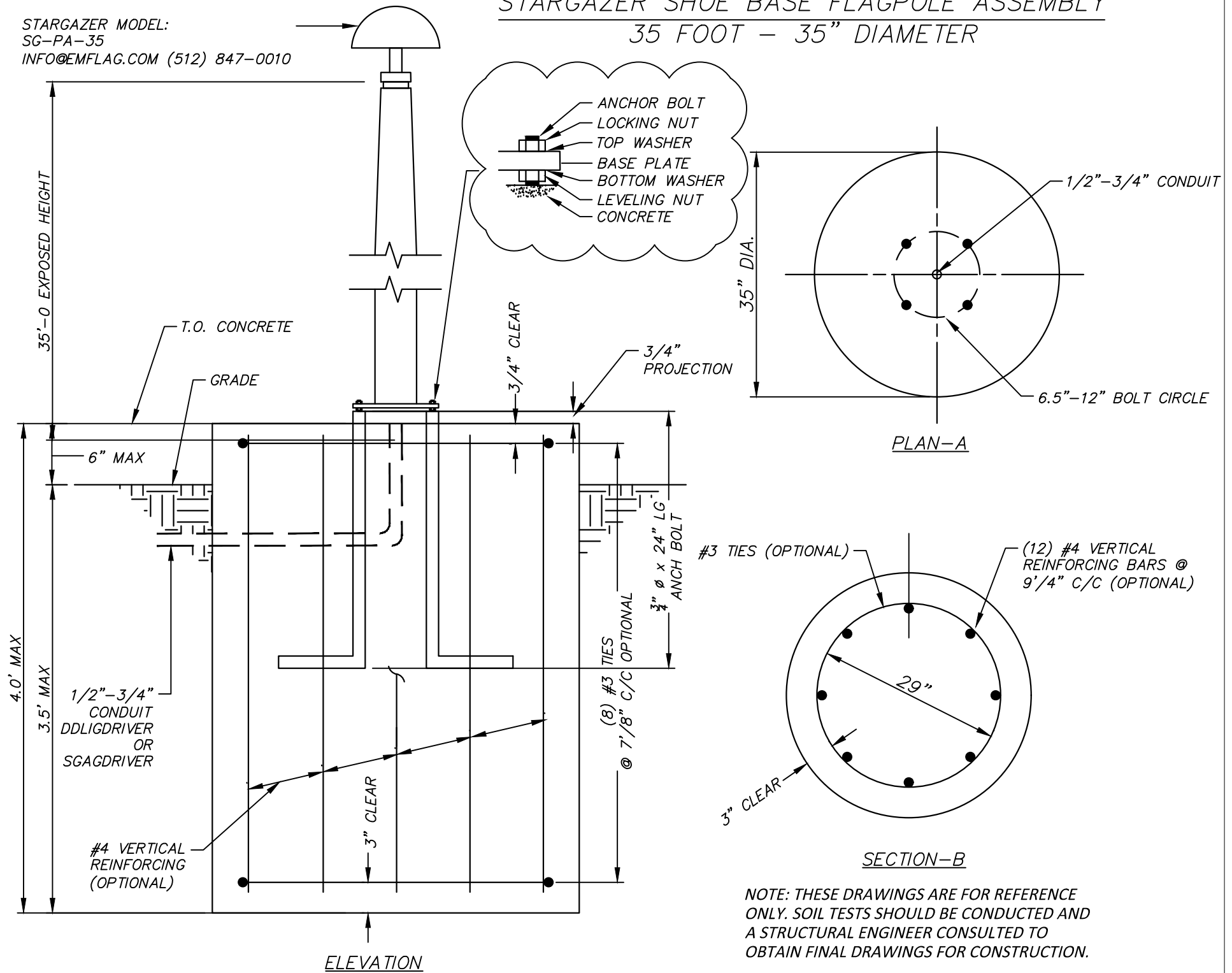

NOTE: THESE DRAWINGS ARE FOR REFERENCE ONLY. SOIL TESTS SHOULD BE CONDUCTED AND A STRUCTURAL ENGINEER CONSULTED TO OBTAIN FINAL DRAWINGS FOR CONSTRUCTION.